

NPD12-250Ah 12V250Ah

Valve Regulated Lead Acid Battery



Specifications

Nominal voltage	12V (6 cells per unit)	
Rated capacity (10HR)	250Ah/10.8V	
Dimensions	Length	521±2mm (20.51inch)
	Width	269±2mm (10.59inch)
	Height	220±2mm (8.66inch)
	Total height	224±2mm (8.82inch)
Approx. weight	75.50kg (166.45lbs)±3%	

Outer dimensions (mm)

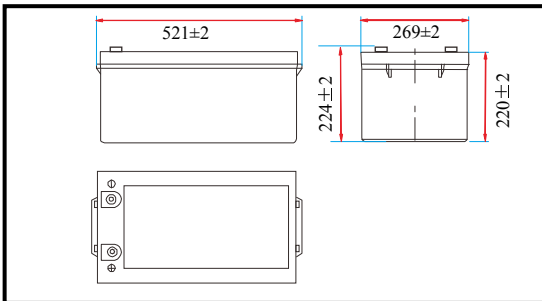

Terminal type (mm)

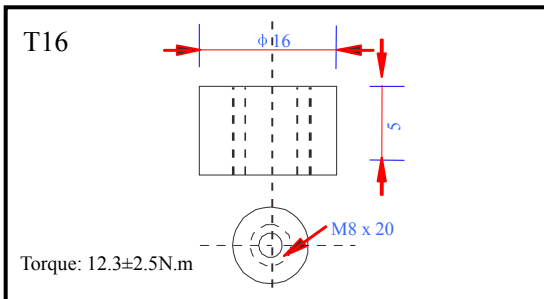

Characteristics

Capacity (25°C)	10HR (10.8V)	250Ah
	3HR (10.8V)	189Ah
	1HR (10.5V)	140Ah
Terminal type		T16
Internal resistance (Fully charged, 25°C)		Approx. 2.6mΩ
Capacity affected by temperature (10HR)	40°C	102%
	25°C	100%
	0°C	85%
	-15°C	65%
Self-discharge (25°C)	3 months	Remaining capacity: 91%
	6 months	Remaining capacity: 82%
	12 months	Remaining capacity: 65%
Nominal operating temperature		25°C±3°C (77°F±5°F)
Operating temperature range	Discharge	-15°C~50°C (5°F~122°F)
	Charge	-10°C~50°C (14°F~122°F)
	Storage	-20°C~50°C (-4°F~122°F)
Float charging voltage (25°C)		13.50 to 13.80V Temperature compensation: -18mV/°C/Block
Cyclic charging voltage (25°C)		14.50 to 15.00V Temperature compensation: -30mV/°C/Block
Maximum charging current		75A
Maximum discharge current		1500A (5 sec.)
Design life	10 years for floating (25°C)	
	Eurobat (20°C): 10/12 years, long life.	

Construction

Component	Positive plate	Negative plate	Container	Cover	Separator	Electrolyte	Safety valve	Terminal
Raw material	Lead dioxide	Lead	ABS	ABS	AGM	Sulfuric acid	Rubber	Copper

Constant current discharge characteristics unit: Ampere/Block (at 25°C, 77°F)

F.V/Time	15min	30min	60min	2h	3h	4h	5h	6h	8h	10h	20h
9.60V	428	256	158	93.2	67.1	53.6	45.8	39.8	31.5	26.0	13.8
9.90V	418	251	155	92.6	66.7	53.3	45.5	39.6	31.3	25.9	13.7
10.2V	403	243	151	91.8	66.3	52.9	45.2	39.3	31.1	25.8	13.7
10.5V	389	238	147	90.4	65.8	52.5	44.9	39.0	30.9	25.7	13.6
10.8V	368	229	142	88.1	63.8	51.0	43.5	37.8	29.9	25.5	13.5

Constant power discharge characteristics unit: Watt/Block (at 25°C, 77°F)

F.V/Time	15min	30min	60min	2h	3h	4h	5h	6h	8h	10h	20h
9.60V	4704	2875	1797	1079	789	630	541	470	374	310	165
9.90V	4591	2818	1770	1073	785	626	538	468	372	309	165
10.2V	4422	2732	1725	1063	779	622	534	464	369	308	164
10.5V	4271	2666	1671	1047	774	618	530	461	367	307	163
10.8V	4045	2568	1617	1021	750	599	515	447	356	304	162

Note 1: Above characteristics data can be obtained within three charge and discharge cycles.

● Discharge characteristics (25°C)

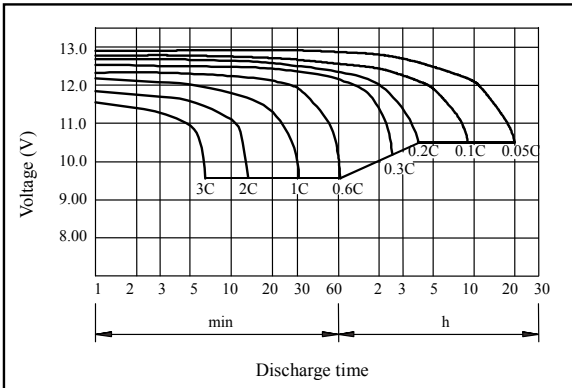

● Charging characteristics (25°C)

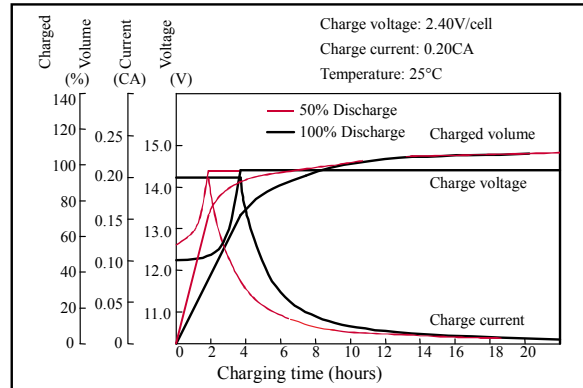

● Temperature effects on capacity

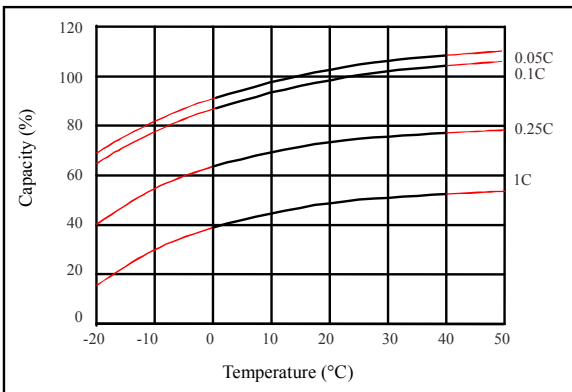

● Self-discharge characteristics

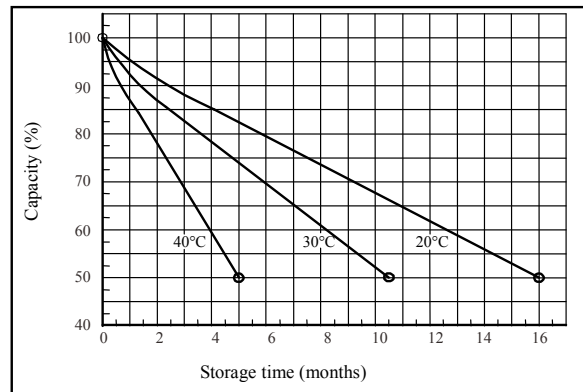

● Floating life on temperature

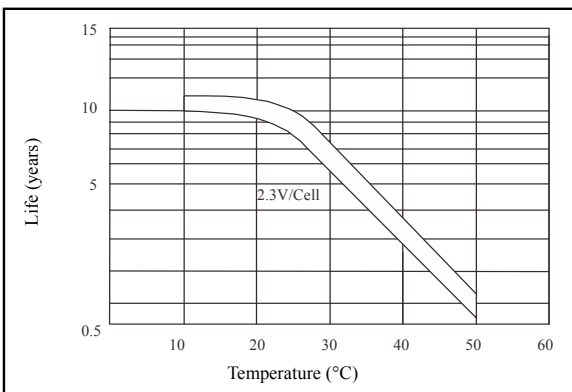

● Cycle life on D.O.D (25°C)

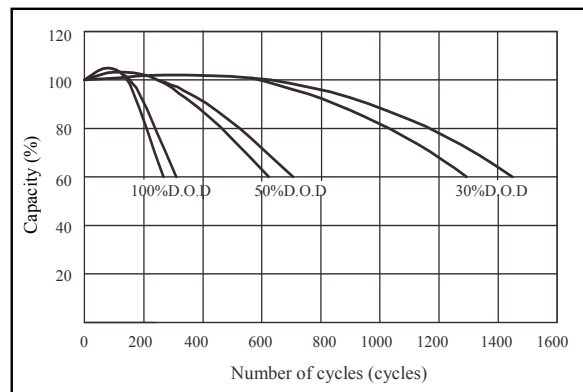

● Relationship for OCV and capacity (25°C)

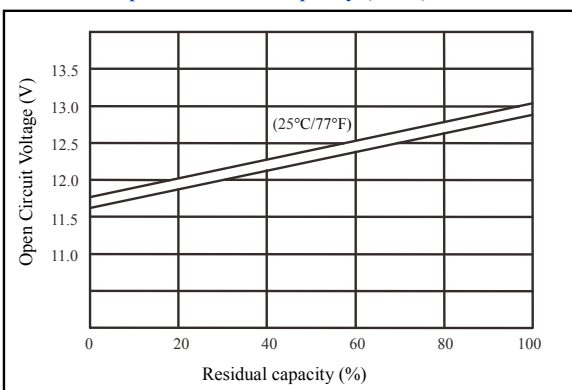

● Relationship for charging voltage and temperature

